



technische import

Productinformatie



A.U.K. MÜLLER GMBH & CO. KG

BAFA.NL

Product Information

Dispense valve, DN 12



A.u.K. Müller

Solenoid valves
Control valves
Special valves and systems

A. u. K. Müller GmbH & Co. KG
Dresdener Str. 162
D-40595 Düsseldorf/Germany

Tel.: +49(0)211-7391-0
Fax: +49(0)211-7391-281

e-mail: info@akmueller.de
Internet: www.akmueller.de

Series 40.012.111



Characteristics

- ✓ direct controlled
- ✓ plunger separated by diaphragm from medium
- ✓ PTFE valve seat to inhibit scale build up
- ✓ long term performance capability
- ✓ flow rate adjustable (flow regulation screw)
- ✓ suitable for food and hot water appliances
- ✓ works from zero pressure
- ✓ similar hydraulic performance for AC or DC types
- ✓ other hydraulic connections on request
- ✓ complete drainage of valve outlet after shut off
- ✓ easy to assemble and service
- ✓ coil change without opening of medium circuit, coil can be mounted 4 x 90°
- ✓ high operating safety through the use of high quality and 100% final testing of the products

Applications

- hot / cold drink dispensers
- tank or boiler draining
- automatic animal feeding equipment

Description

2/2-way solenoid valve of nominal diameter DN 12 for liquid dispense. This valve is direct controlled and normally closed (NC).

Valves of this design are medium separated seat valves, where the plunger is separated by a diaphragm from the medium. The valve seat is made of scale build up inhibiting PTFE.

This valve can be manufactured with a variety of customised connections in DC or AC voltage. Low power or PPM triggering can be used.

Electrical operating safety is achieved by PBT coating of the coil and can be supported by an additional protection circuit.

The valve is available in different PSU valve body types and is distinguished primarily by its food grade and hot water capability.

Possible approvals

Approved versions available on request:

- NSF 169
- WRAS
- KTW/W270
- UL
- Others on request

typical performance curve

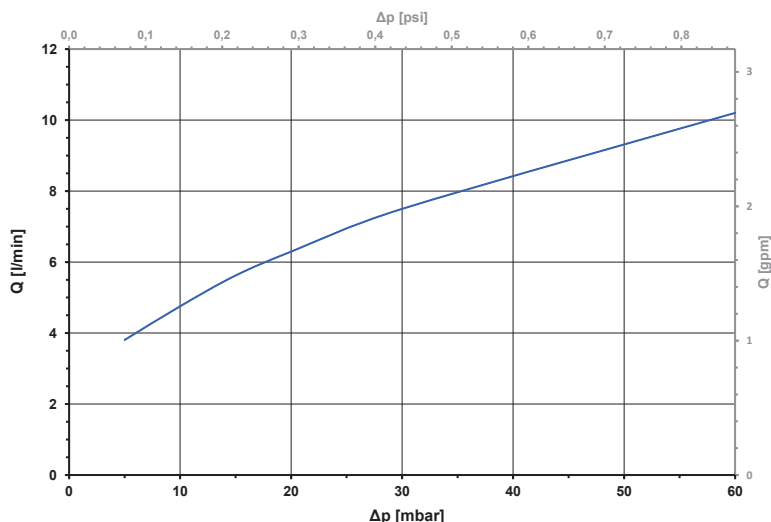



Series 40.012.III

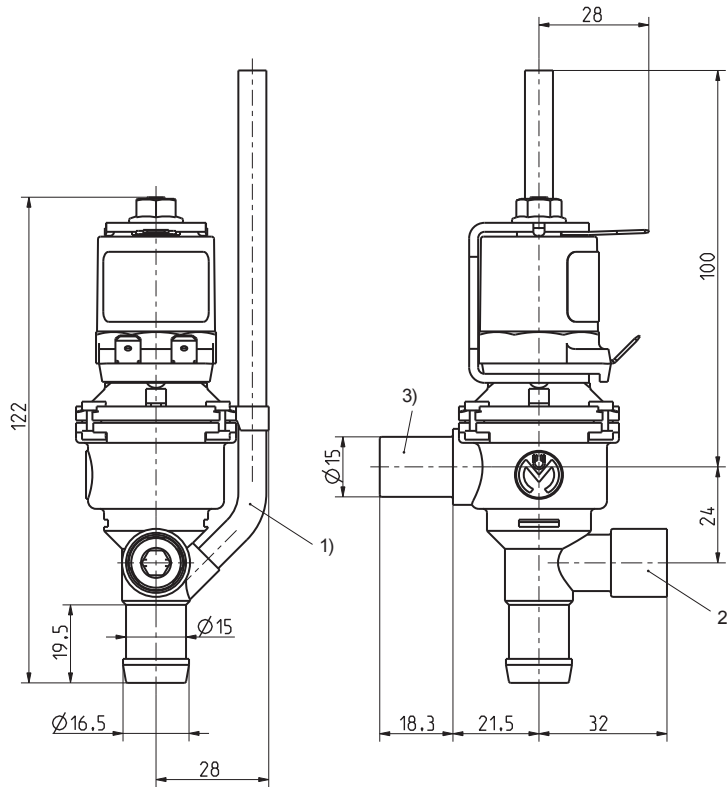

Materials	
Valve body	PSU
Valve seat	PTFE
Plunger guide	stainless steel
Plunger	stainless steel
Membrane and sealings	VMQ
Coil coating	PBT, PET or epoxy resin

Valve body version ~001

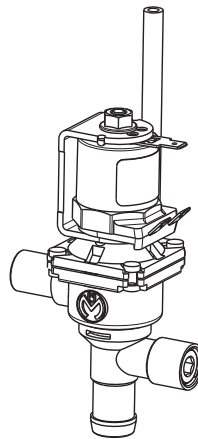

Options	
1)	Ventilation of outlet nozzle to drain downstream tubing completely. Different lengths of breather tube on request.
2)	Regulation screw for vernier adjustment of flow.
3)	Different inlet nozzels and boiler sealings on request

Technical Data

Type	dispense valve	
Construction	2/2-way single chamber valve inlet ninety degree to the outlet, direct acting	
Function	NC (normally closed)	
Fitting position	coil pointing upwards	
Media	cold and heated potable water and physically and chemically similar media	
T-Medium	98	°C max.
T-Ambient	70	°C max.
DN	12	mm
Flow	adjustable at nozzle	
p-Operating	0 - 60	mbar
Coil type	MS.006, MS.024, MS.025	
Nominal voltages	230	V AC 50/60 Hz
	110	V AC 50/60 Hz
	24	V AC 50/60 Hz
	24	V DC
other voltages on request		
Voltage tolerance	+10% -15%	
Duty cycle	50% (30 s on/30 s off)	
Nominal power	9,5 W	16,4 VA (AC only)
Protection type	IP 00	higher IP-classes on request
Coil connection	flat tabs 6,3 x 0,8 mm (others on request)	
Insulation class	F	according to EN 60730
Protection class	I	according to EN 60730 (for incorporation in class I)

MS.006 (IP00)	
MS.024 (IP65)	
MS.025 (IP67, IP68)	

Series 40.012.III

With regulating screw and ventilation of outlet nozzle

Valve body version

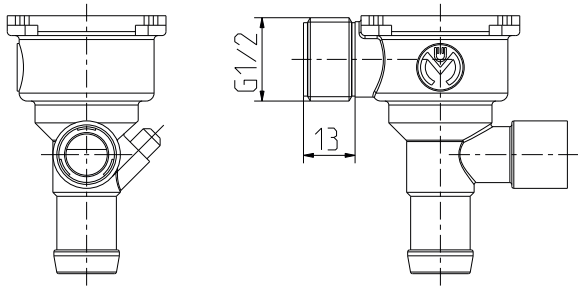

~002

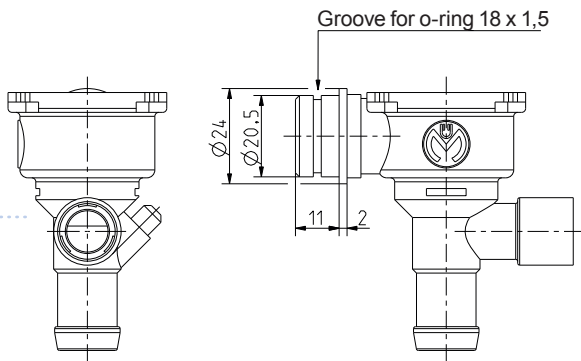
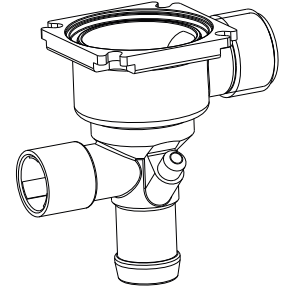

~004

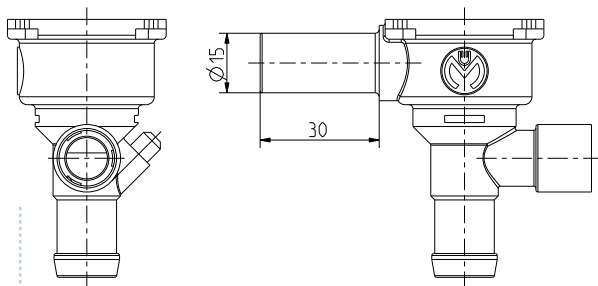
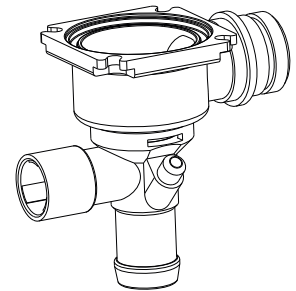

~005

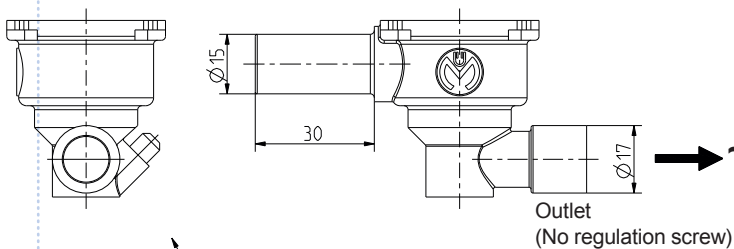
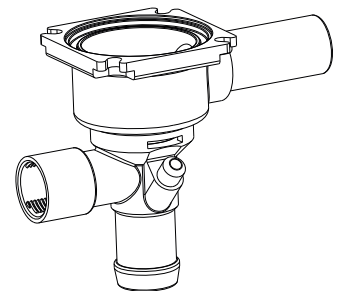

~015

Outlet
(No regulation screw)

Without breather

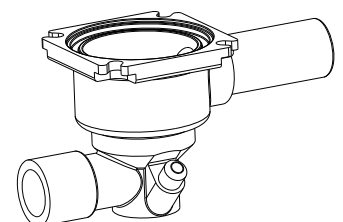



Series 40.012.111

Tank sealings material: VMQ

For valve body version

ID.

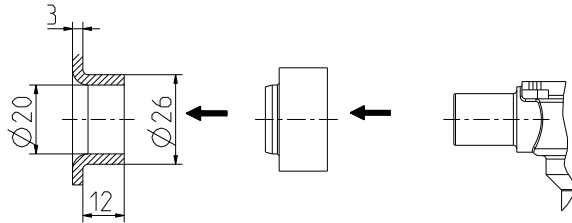

~001

004966



Seal for tank inlet nipples

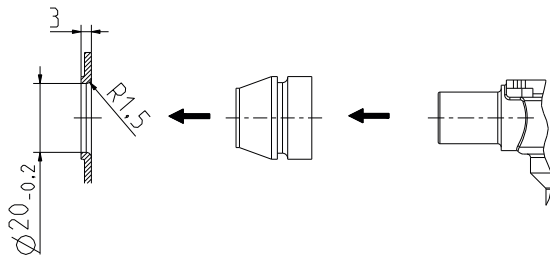
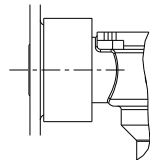

~001

006723



seal for circular tank holes

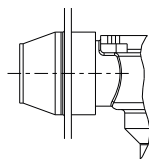

Product Information

Dispense valve, DN 12



A.u.K. Müller

Series 40.012.III

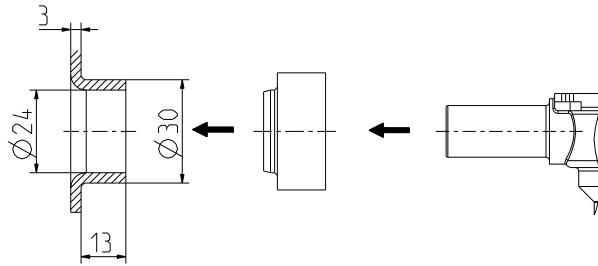

For valve body version

ID.

~005
~015

006432



Seal for tank inlet nipples

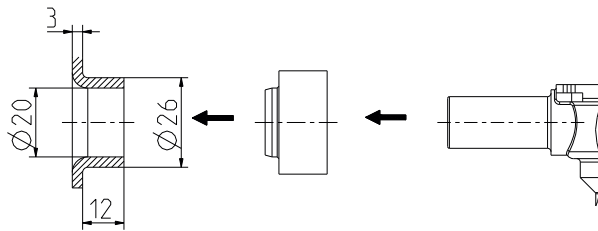
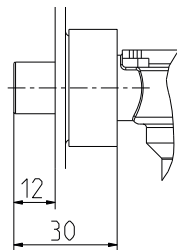

~005
~015

004966



Seal for tank inlet nipples

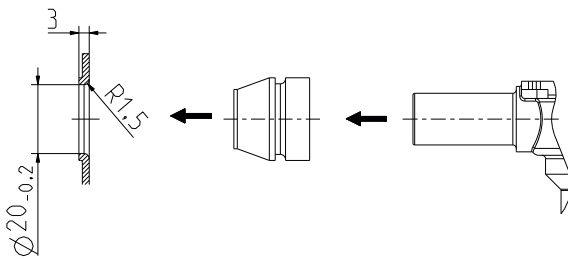
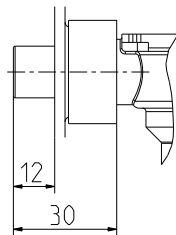

~005
~015

006723



seal for circular tank holes

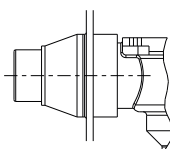



technische import

Nijverheidsweg 11
7005 AS Doetinchem
T. +31 (0) 314-344342
E. info@bafa.nl

BAFA.NL